

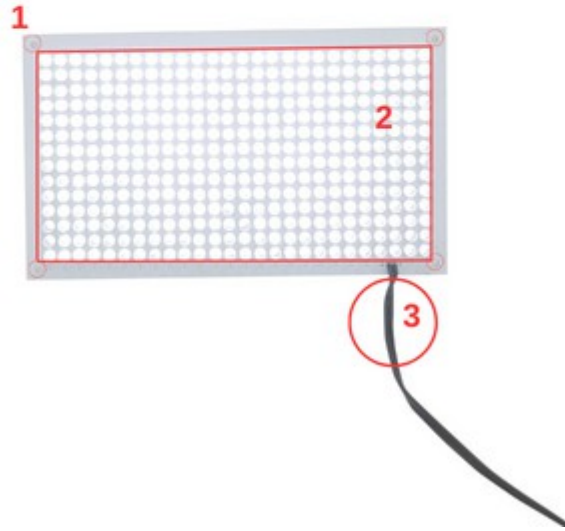

Prion Industrial Lighting

Back Lights

L1426



Product Name	Dimensions	Number	Statement
L1426	Widht: 179 mm	1	Connection Hole
	Heigh: 25 mm	2	Lighting Zone
	Lenght: 105 m	3	Product Cable





1.FEATURES

- Lighting Color: 6000K, Green, Red
- Lighting Angle: 30°, 60°
- Intensity Of Illumination: 0,910 lm
- Led Number: 364
- Input Voltage: 24 V
- Input Current (15 μ s): 1,3 A
- Input Current (1 second): 0,83 A
- Input Current (1 minute): 0,67 A
- Input Current (continuous): 0,52 A
- Dimensions: 17,9 cm x 10,5 cm x 2,5 cm
- At Constant Voltage Operation: Have
- Diffusor Option: There Are

3.APPLICATIONS

- Engine Part Inspections
- Packaging Inspections
- Medical Bottle Inspections
- Food Package Inspections
- Surface Inspections
- Microscopic Camera Applications
- Particle Imaging in Liquid
- Particle Size Measurement
- Particle Counting
- Machine Vision
- Cell Identification
- Flame Length Measurement
- Edge Detection
- Material Strain Measurement (elongation / shortening / degradation)
- Motion Detection
- Product Counting
- Color Concentration Information
- Coordinate Information

2.DESCRPTIONS

- Backlight lightings include various options suitable for projects with different angles and color options. It is used in all areas where there is a camera and used in the field of artificial image processing. however, it is preferred in machine lighting and used in special machine lighting.

- Particle Identification
- Cell Imaging
- Machine Monitoring
- Image Processing
- Industrial Led Lighting
- Conveyor Line Lighting
- Robot Vision Applications
- Industry 4.0 Applications
- Machine Lighting
- Bar Light
- Dark Field Light
- Panel Lighting
- Dark Effect Lighting
- Dome Light
- Ring Light
- Panel Light
- Back Light
- Dome Type
- Lighting

4.LIGHT CHARACTERISTICS





Prion Industrial Lighting

Back Lights

L1426

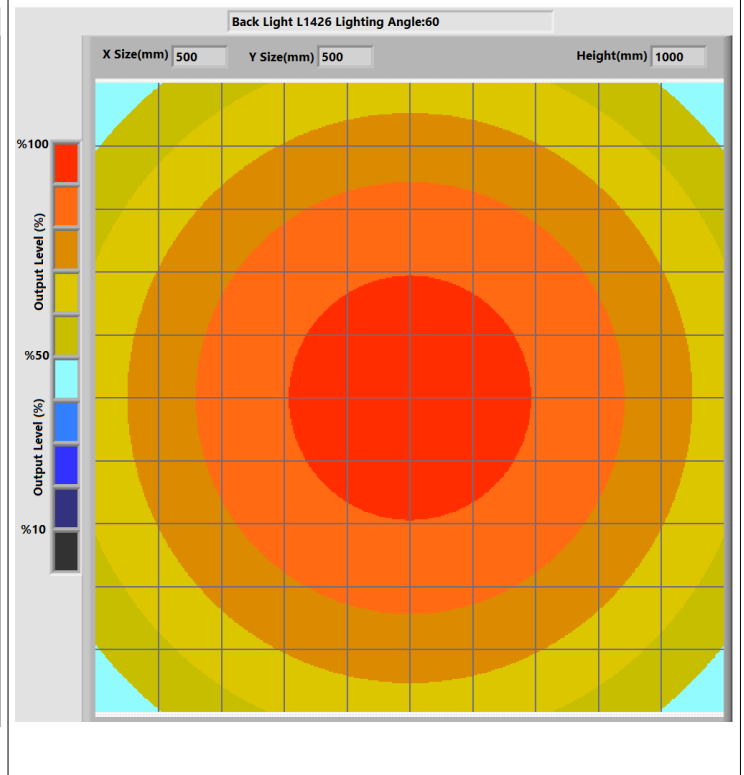
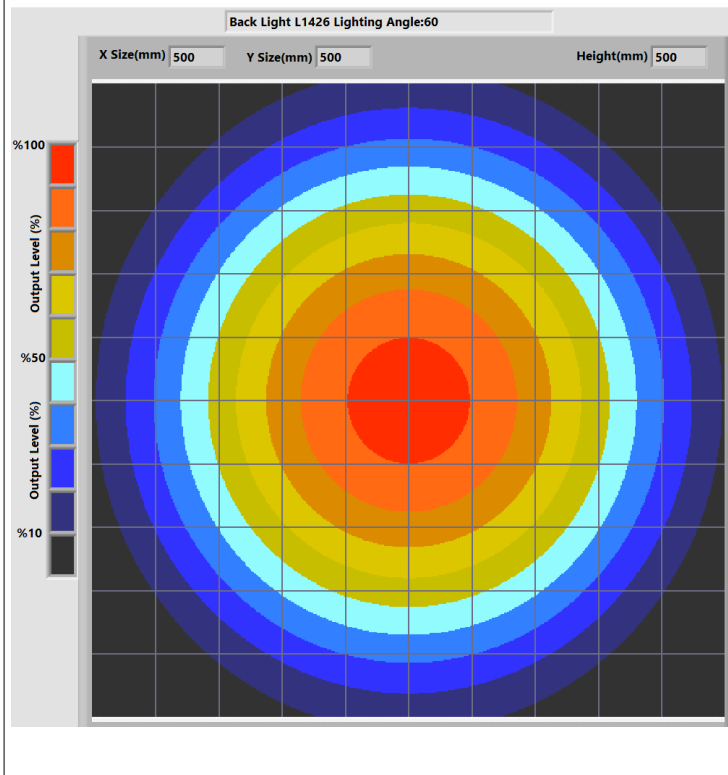
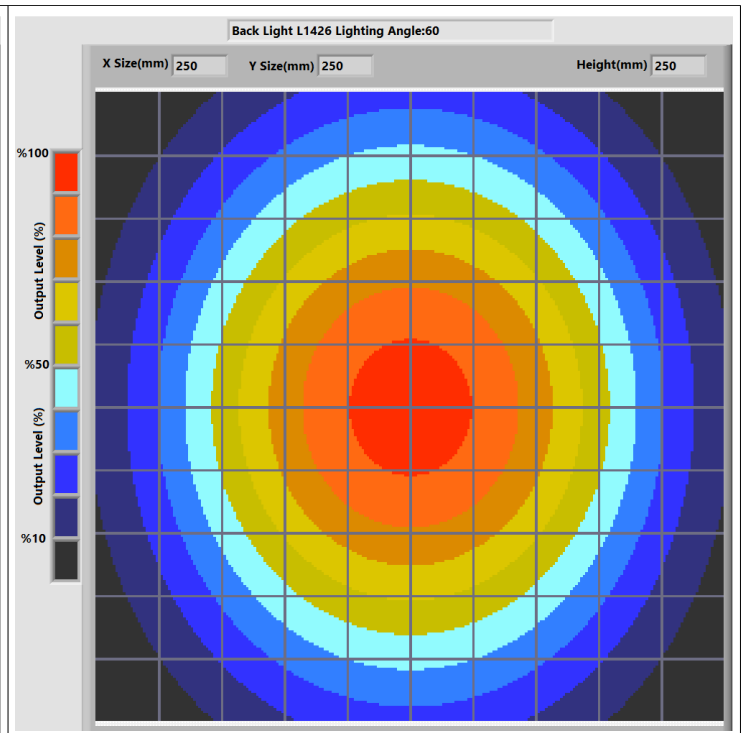
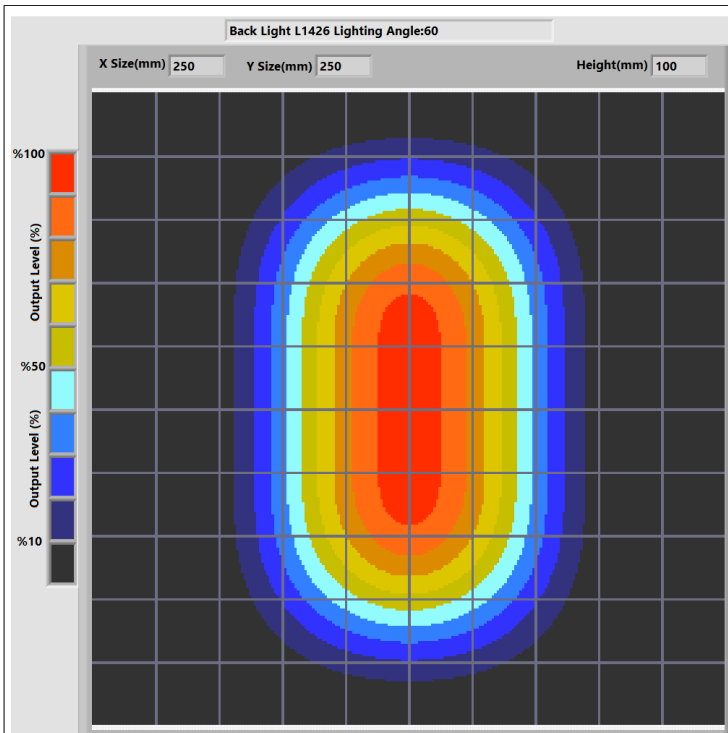

Pelin Street, Nuhöglü Stage 2
Kadıköy/İstanbul/Turkey

E-Mail: info@ludre.com.tr
Contact: +90 216 519 08 54



Prion Industrial Lighting

Back Lights

L1426

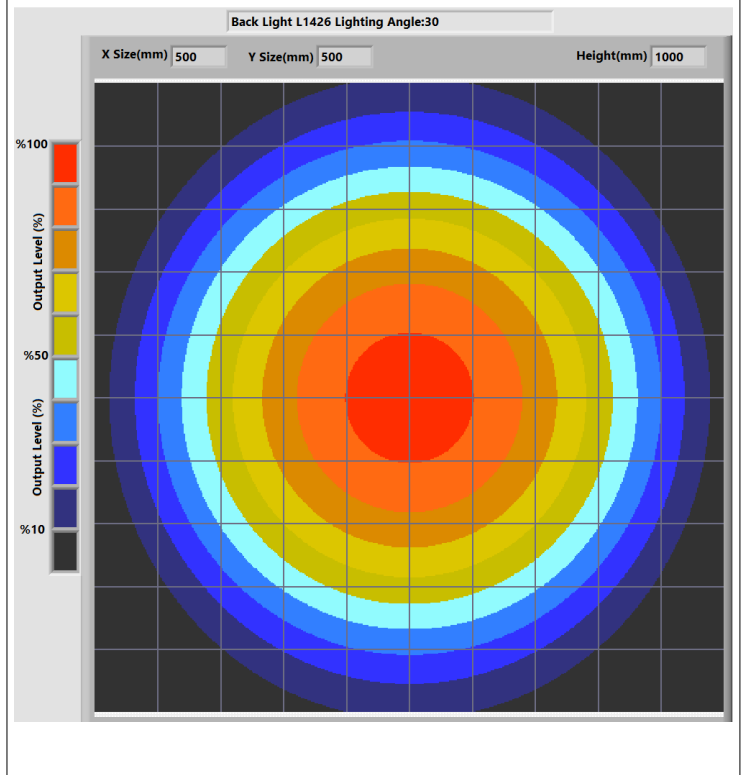
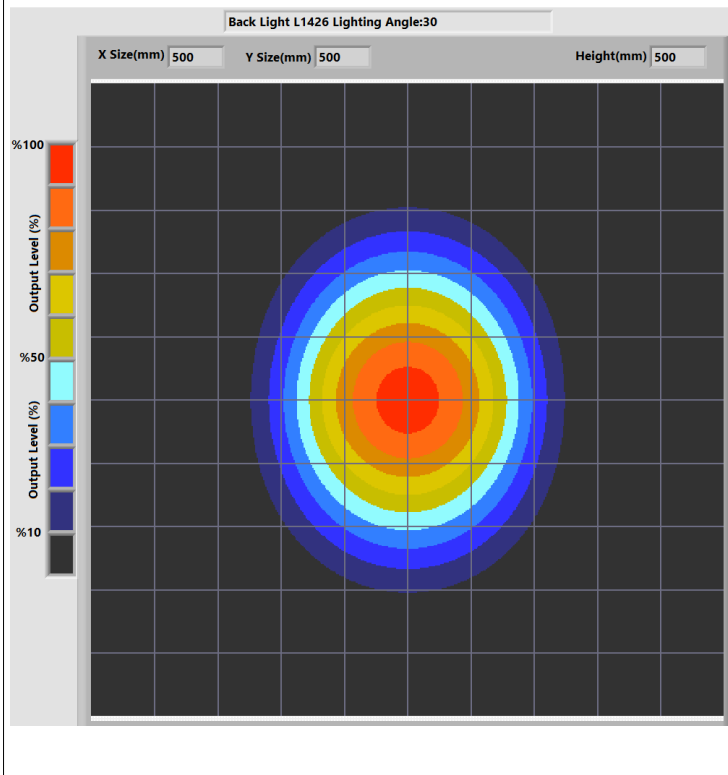
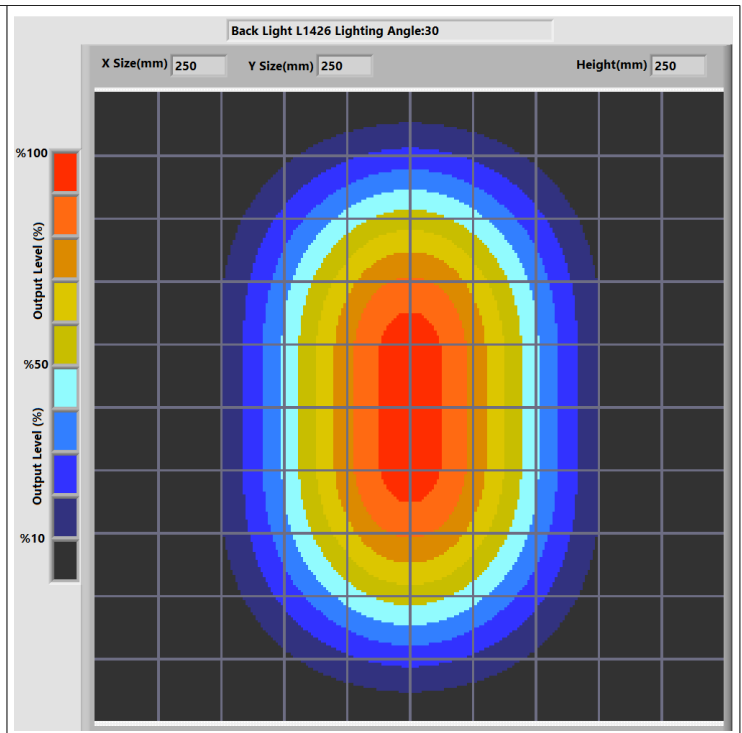
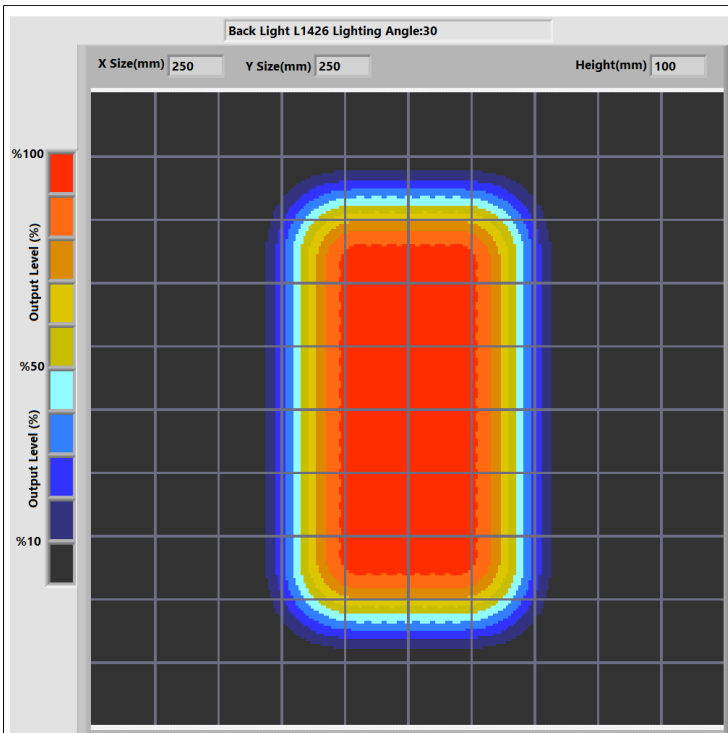

Pelin Street, Nuhoglu Stage 2
Kadiköy/İstanbul/Turkey

E-Mail: info@ludre.com.tr
Contact: +90 216 519 08 54



Prion Industrial Lighting

Back Lights

L1426

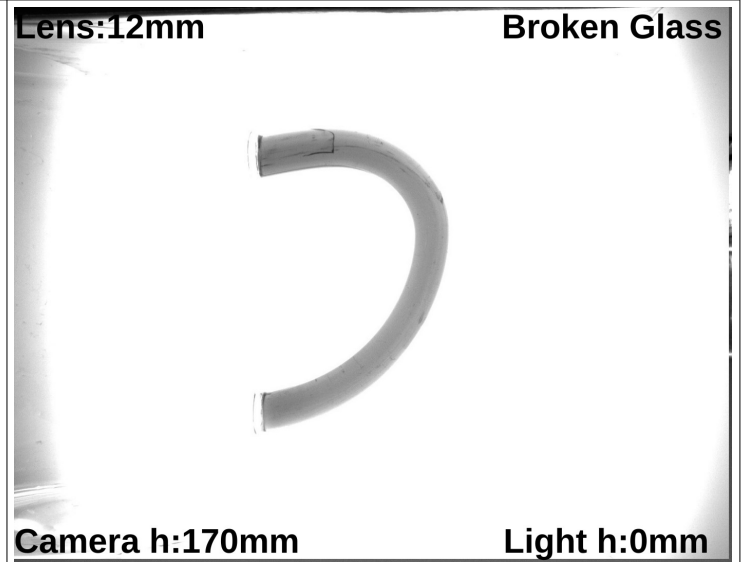
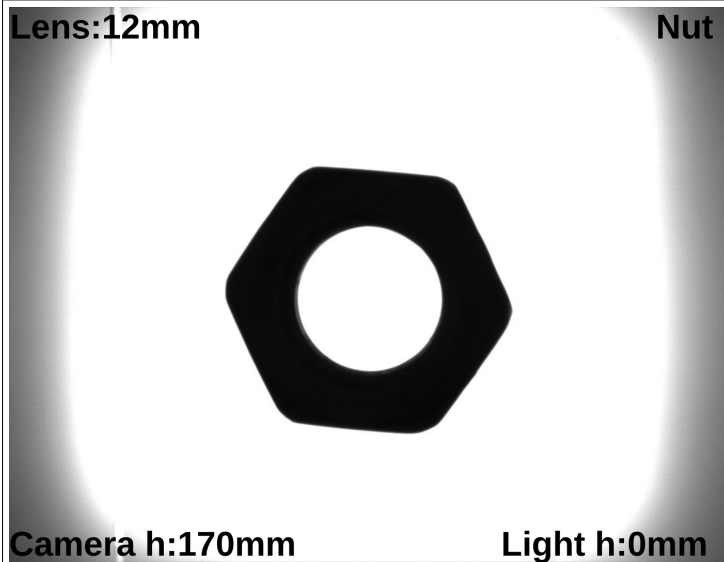
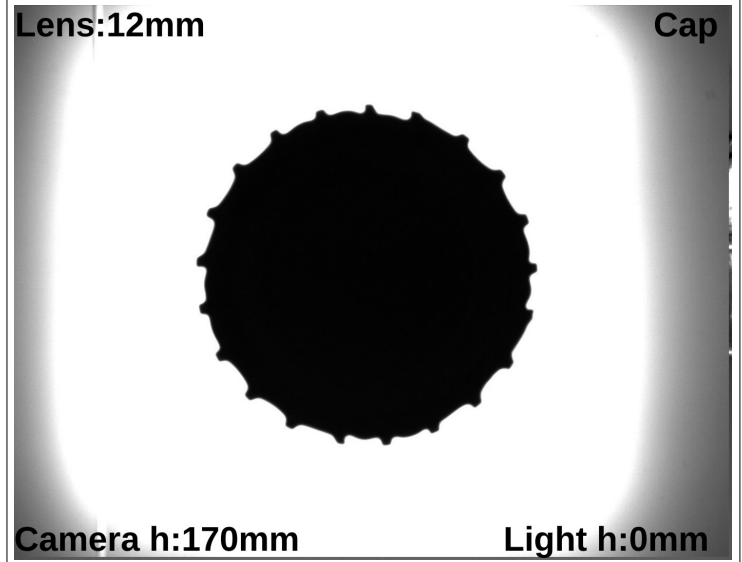
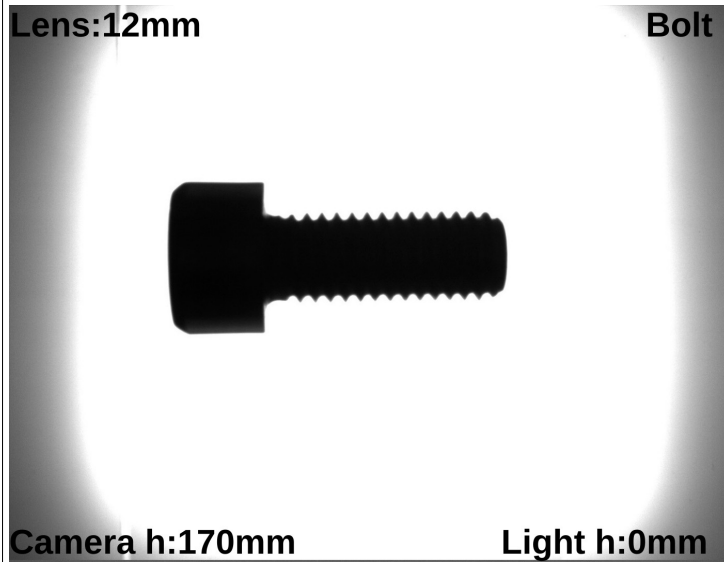

5.PRODUCT USE

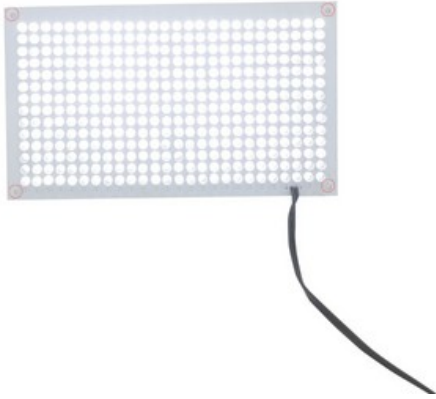
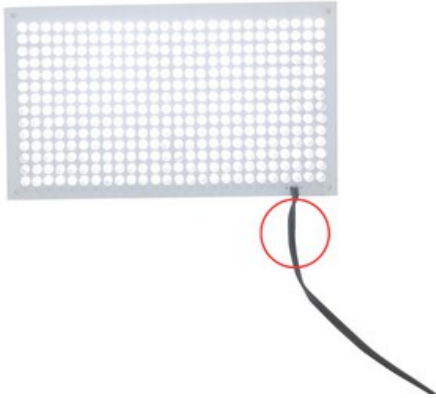
	<p>Mounting to the machines is possible with the bolt and nut assembly in the areas indicated in the adjacent image. The points to be taken into consideration during this installation are as follows: The electronic parts should not be contacted while assembling the product. In addition, if the product is not installed properly, vibrations that may occur will cause errors during measurement and control.</p>
	<p>The product is powered by a 2M long cable fixed on it. We need to make the 24V DC+ connection from our cable line with a red stripe, and we need to make the GND connection from our single color cable line. When the supplies are connected in reverse, the product will not be damaged, but the product will not work. Cuts, breaks, etc. on the cable. If there is a problem, please contact us before using the product.</p>

6.DIMENSIONS

Boyutlar ; 4.15x7.05 inç(10.541x17.907 cm)

